

Road Service Quick Reference Guide 2016-2017 Range Rover



Quality and Education Services
AAA Automotive
1000 AAA Drive
Heathrow, FL 32746

March 31, 2017



Index

Quick Specifications and Information	2
Start/Stop Switch Operation	2
Hood Release	3
Rear Hatch Release	3
Electronic Parking Brake (EPB)	4
Towing, Loading and Transporting	5
Selecting Neutral	7
Neutral-Shift Interlock Override	8
Jacking and Tire Service	9
Fuel Service	12
Jump-Start Procedure	13
Electronic Key	14
Lockout Procedure	15

Important Notice:

This publication should not be used while driving. The procedures in this publication should only be used by qualified and trained personnel.

This Road Service Quick Reference Guide was developed to highlight some model-specific information and common procedures for servicing or towing this vehicle. It is not all-inclusive. For complete information: The applicable vehicles owner's manual and the AAA Towing and Service Manual should be used in conjunction with this guide.

The procedures recommended and described in this guide are effective methods of performing light service and towing operations. Some of these procedures require the use of auxiliary equipment specially designed for the purpose. The auxiliary equipment should be used when and as recommended and whenever the trained operator deems it appropriate. It is important to read the various WARNINGS, CAUTIONS and NOTES in this manual in order to minimize the risk of personal injury to service personnel and or customers and to avoid procedures which may damage the vehicle or render it unsafe. It is also important to understand that these warnings, cautions and notes are not exhaustive. Neither AAA nor the auto and towing equipment manufacturers could possibly know, evaluate and advise the reader of all conceivable methods of towing or evaluate individual situations. Accordingly, anyone who uses a towing procedure must be thoroughly convinced that neither personal safety nor vehicle safety will be jeopardized by the selected procedure.

AAA is not responsible for changes made by the manufacturers to the vehicles or their recommendations. Important changes in procedures and updates will be furnished to all manual users at AAACampus.aaa.biz.

QUICK SPECIFICATIONS AND INFORMATION:

Available Drivelines: 4 Wheel Drive

Range Rover	Base Curb Weight	Front Axle Weight	Rear Axle Weight
5-Seat Gasoline:	5,417 lbs.	3,250 lbs.	2,167 lbs.
7-Seat Gasoline:	5,542 lbs.	3,325 lbs.	2,217 lbs.
5-Seat Diesel:	4,861 lbs.	2,917 lbs.	1,944 lbs.
7-Seat Diesel:	5,161 lbs.	3,097 lbs.	2,064 lbs.

Note: Weights represent the heaviest optioned models available.

Dimensions:



	Length	Width
Range Rover Standard Wheelbase:	196.6 in.	81.6 in. (mirrors folded in)
Range Rover Long Wheelbase:	204.7 in.	81.6 in. (mirrors folded in)

- Lug Nut Torque 98 lb. ft. (133 Nm)
- Inflate the temporary spare to 60 psi
- Premium Fuel is recommended (gasoline engines only, see Fuel Service for details)

START/STOP (IGNITION) SWITCH OPERATION:

Note: The electronic key must be in the vehicle. When not detected, a message will display on the driver's display panel.

- **Ignition On-engine Off:** Press the Start/Stop switch **without** depressing the brake pedal.
- **Starting the engine:** Press the Start/Stop switch **while** depressing the brake pedal.

HOOD RELEASE:

To Open the Hood:

- Pull the hood release handle located on the driver's side of the footwell.
- The secondary hood release lever is located underneath the center of the hood. Release by lifting up on the lever.

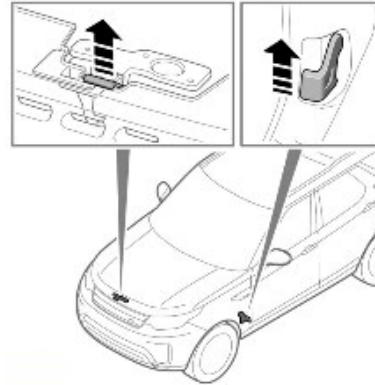

REAR HATCH RELEASE:

The Following Methods will Release the Rear Hatch:

- Press the rear hatch release button on the electronic key.

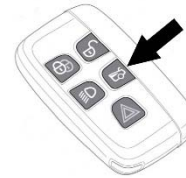

- Press the rear hatch release button on the dashboard.



- Range Rover: Press the exterior rear hatch release button (1) on the rear hatch and lift the hatch, and then press the tailgate release button (2) on the tailgate and lower the tailgate.

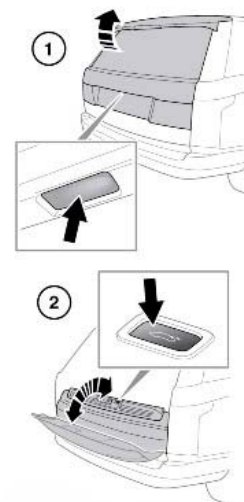

ELECTRONIC PARKING BRAKE (EBR):

Operation:

Note: The EPB can be applied with the ignition On or Off. The ignition must be On to release the EPB.

Electronic Parking Brake (EPB) warning lamp:

When illuminated the EPB is correctly applied. If the lamp flashes, a fault has been detected.



US

Canada

- To apply the EPB: Lift the EPB switch briefly.
- To release the EPB, depress the brake pedal and press down on the EPB switch briefly.

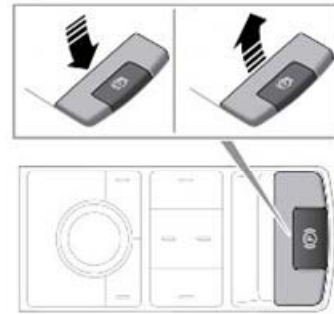

Note:

- The EPB applies automatically when **P**ark is selected or when the ignition is switched Off.
- To release the parking brake when the battery is discharged, connect a booster pack to the jump-start pins in the engine compartment and operate the EPB switch normally.
- To prevent automatic operation, when the vehicle is stationary, press and hold the EPB switch in the release position. Within 5 seconds, switch off the ignition and continue to hold the EPB switch for an additional 2 seconds.

WARNING: Do not connect the booster pack directly to the vehicle's battery or damage to the electrical system may occur.

TOWING, LOADING AND TRANSPORTING:

The use of car carrier equipment is the preferred method of towing this vehicle. A secondary, alternative wheel lift with dollies on the road wheels may be used when a car carrier is not a practical solution. Additional ramping may be required when loading the car onto the car carrier.

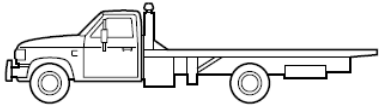

Car carrier is the recommended towing procedure.

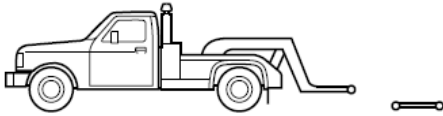

Secondary, Alternative Procedure: Wheel lift with dollies for 4 wheel drive. This method should be used when a car carrier is not a practical solution.

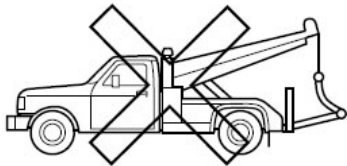

Slingbelt towing is not an approved procedure. Vehicle damage may occur by this means.

Car Carrier Loading:

Caution: This vehicle is equipped with air suspension. The air suspension shuts off a few seconds after the ignition is turned off and can settle during transport.

The vehicle is loaded onto the flatbed using loading attachment points. The front loading attachment point is permanently attached to the vehicle. The rear loading attachment point may be either permanently attached or a removable eyebolt depending on the vehicle. The loading attachment points are used for vehicle loading only. If used for any other purpose, vehicle damage, serious injury or death may result. Do not use the attachment points to secure the vehicle to the car carrier, use wheel straps only. A secondary tether strap is recommended as a safety measure for loading. See the Securing the Vehicle for Transport section for more details.

Front Loading Attachment Point Access:

- The front loading attachment point is located behind a cover in the front of the vehicle. Remove the cover by turning the fasteners using a screwdriver or coin. Use caution not to scratch or damage the cover or bumper. After removal, place the cover and fasteners inside the rear cargo area of the vehicle to prevent loss.

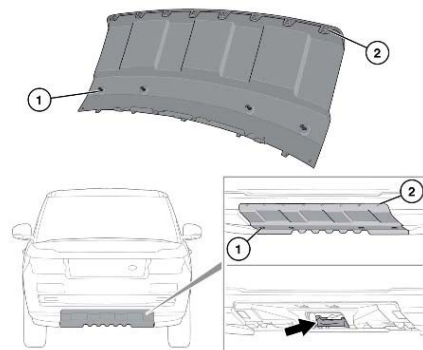

Rear Loading Attachment Point Access:

- Remove the cover by turning the fasteners using a screwdriver or coin. Use caution not to scratch or damage the cover or bumper. After removal, place the cover and fasteners inside the rear cargo area of the vehicle to prevent loss.
- On vehicles equipped with a factory installed trailer hitch, the rear loading attachment point is part of the hitch receiver located behind a cover in the rear of the vehicle.
- On vehicles not equipped with a factory installed trailer hitch, the rear loading attachment point is located behind a cover in the rear of the vehicle. To install the eyebolt, turn it counter-clockwise into the receiver until fully seated. Rusted threads may require the use of a large screwdriver or ½ in. drive socket extension to assist in threading the eyebolt into position.

Caution: Do not apply excessive force or over-tighten. Thread damage may occur.

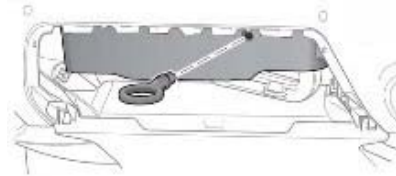
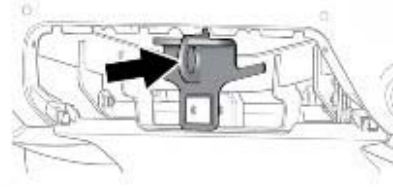
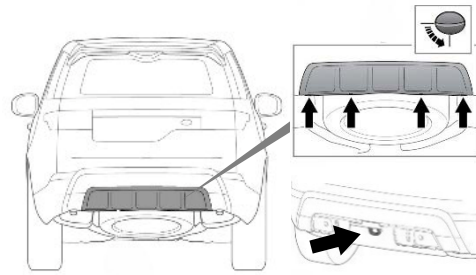

SELECTING NEUTRAL:

The transmission uses an electronic gear selector that prevents the transmission from being placed in Nutral unless the engine is running. A shift interlock override is used to mechanically place the transmission in Nutral for flatbed loading and unloading.

Caution: Secure the vehicle to ensure it will not roll. Deploy wheel chocks.

Choose the correct method based on the condition of the vehicle:

Placing the Vehicle in Nutral -- Minor Mechanical, Engine Starts:

This procedure for selecting Nutral should only be used if vehicle's engine can be safely started without causing further mechanical damage. An example would be a vehicle being towed for multiple flats or a non-engine related minor mechanical condition.

Caution: You must use wheel chocks to secure the vehicle until you are ready to load.

Step 1 Selecting Nutral:

Deploy wheel chocks to secure the vehicle.

- With the electronic key inside the vehicle, press the Start/Stop switch once while depressing the brake pedal to start the vehicle. Continue to press on the brake pedal.
- The gear selector knob will rise from its retracted position in the console.
- The transmission will initially be in Park. Rotate the gear selector knob to Nutral.
- Press the Start/Stop button once to turn the vehicle off. The vehicle will remain in Nutral; however, the EPB is automatically applied.
- Release the brake pedal.



Step 2 Disabling the Automatic Parking Brake

Feature:

- Without pressing the brake pedal, press the Start/Stop switch once to turn the ignition to On.
- Press and hold the brake pedal.
- Press down on the EPB switch to release the parking brake.
- Release the brake pedal.
- Press and hold down the EPB switch.
- Press the Start/Stop switch while continuing to hold the EPB switch down. Continue to hold for 5 seconds.
- Release the EPB switch.

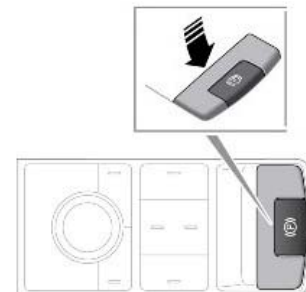

At this point, the vehicle should be in Nutral with the parking brake released, and can be loaded onto the car carrier.

Placing the Vehicle in Neutral -- Without Starting the Engine:

Note: This method should be used when the engine cannot be started.

Operating the Shift Interlock Override:

The shift interlock override is located in the engine compartment on the driver's side of the intake manifold. To access, carefully remove the black plastic cover on the intake manifold by lifting upward.

- Lift the black lever on the shift interlock override to the vertical position (1).
- Engage the securing latch to hold the handle in position (2).
- The transmission will remain in Neutral until the shift interlock override is released.
- To return the transmission to Park, release the securing latch (2) and move the lever (1) back to the horizontal position.

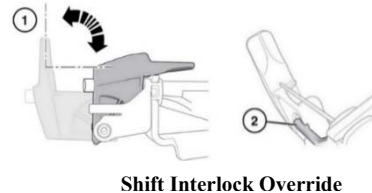

Releasing the Parking Brake:

The EPB applies automatically when the ignition is turned Off. To temporarily disable the parking brake:

- With the ignition On-engine Off, depress the brake pedal and press down and hold the EPB switch.
- **Within 5 seconds**, turn the ignition Off.
- Continue to hold down the EPB switch for 2 more seconds. The parking brake will remain released until the next time the ignition is cycled On and Off.

Caution: If the ignition is cycled On and Off, this procedure must be repeated.

Releasing the Parking Brake when the Battery is Discharged:

Connect a booster pack to the jump-start pins in the engine compartment and operate the EPB switch normally.

Note: If the EPB to release or Neutral cannot be selected, use wheel skates or wheel dolly jacks on the non-rolling wheels to load the vehicle.

WARNING: Do not connect the booster pack directly to the vehicle's battery or damage to the electrical system may occur.

Securing the Vehicle for Transport:

Only wheel straps should be used to secure the vehicle for transport. Damage may occur if wheel straps are not used. When the vehicle is in its loaded position on the flatbed with the bed still in the deployed position, secure the vehicle to prevent it from rolling by chocking the wheels and attaching one wheel strap to the wheel closest to you. Follow all normal loading procedures to tie down the rest of the vehicle and secure it for safe transport.



Caution: Do not over tighten the wheel straps or the vehicle may be damaged. Make sure no metal portions of the strap contact the wheel. Avoid scratching any surfaces with the wheel straps.

Placing into Park for Transport: Once the vehicle is secured to the carrier. Reverse whatever method was used to gain Neutral and restore the vehicle to the Park position to assist in stabilizing the vehicle for transport.

Car Carrier Unloading:

When unloading, reverse the steps used to load the vehicle. Be sure to secure the vehicle by returning it to Park and applying the parking brake or wheel chocks if the parking brake will not apply.

JACKING AND TIRE SERVICE:

Spare Tire Change Procedure:

Note: This vehicle is equipped with air suspension. Make certain that the ignition is Off before jacking the vehicle.

Air Suspension Caution: For vehicles fitted with air suspension, select the Off-Road Height setting before jacking the vehicle. The electronic air suspension system controls are located on the center console.

- Start the vehicle and press and release the Up button to raise the suspension height. If a door is open, press and hold to raise the suspension height. The button's LED indicator lamp illuminates during suspension height adjustment and extinguishes when complete.
- The Off-Road Height indicator lamp illuminates when the suspension is set to Off-Road Height.
- Before jacking the vehicle, chock the tires and set the parking brake to ensure the vehicle will not move.

- Ensure the temporary spare tire is in serviceable condition and is inflated to the proper pressure. Tire pressure specifications are listed on the Tire Pressure label, located on driver's door opening.



Spare Tire Location:

Caution: When removing the tire from the rear cargo area, prevent scratches or other damage by protecting the bumper and other painted surfaces with a fender cover.

Note: Locking wheel nuts (if equipped) must be removed and reinstalled using a special adaptor, which can be found in either the vehicle's tool kit or the glovebox. Be sure to return the adaptor to its original location and notify the member/customer where you stowed it.

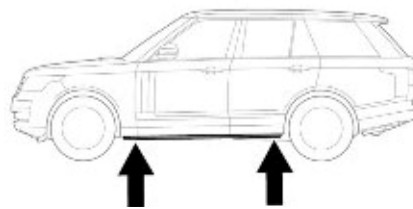

Jacking Points

Use the jacking points shown above. Place the jack in its proper location. Observe all standard jacking precautions and ensure that the vehicle is on firm, level ground and that the wheels are chocked. As the jack comes in contact with the vehicle body, ensure that it is contacting the correct and solid location on the vehicle.

Caution: If the vehicle is equipped with side steps or side tubes, do not use them as jacking points.

Wheel Installation:

When a wheel is installed, always remove any corrosion, dirt or foreign materials present on the mounting surfaces of the wheel or the surface of the wheel hub, brake drum or brake disc that contacts the wheel. Make sure that any fasteners that attach the rotor to the hub are secured so they do not interfere with the mounting surfaces of the wheel. Installing wheels without correct metal-to-metal contact at the wheel mounting surfaces can cause the wheel nuts to loosen and the wheel to come off while the vehicle is in motion, resulting in damage and loss of control.

Wheel Lug Nut Torque Specifications:

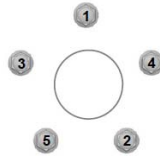

**Incrementally Torque Lug Nuts in the Pattern Shown Above to:
98 lb. ft. (133 Nm)***

*Torque specifications are for nut and stud threads free of dirt and rust.

WARNING: Failure to follow these precautions could cause the wheel nuts to loosen and the tire to fall off, resulting in vehicle damage, serious injury or death.

- Never use oil or grease on the wheel bolts or wheel nuts. Oil and grease may cause the wheel nuts to be excessively tightened, leading to bolt or disc wheel damage. In addition, the oil or grease can cause the wheel nuts to loosen and the wheel may fall off, causing a serious accident. Remove any oil or grease from the wheel bolts or wheel nuts.
- When installing a tire, only use wheel nuts that have been specifically designed for that wheel.
- Check for any cracks or deformities in the bolt screws, nut threads or bolt holes of the wheel.
- Never install a wheel with excessive rust. Light surface rust should be cleaned off the wheel and mounting surface.
- Never install a tire with excessive tread wear or obvious defects.

Stowing the Flat Tire:

The flat tire should be properly stowed and secured in the spare tire well.

Note:

- Inform the member/customer not to exceed 50 mph (80 km/h) while a temporary spare tire is installed.
- Have the lug nuts tightened to the specified torque as soon as possible and no more than 100 miles (160 kilometers) after changing a flat tire.
- Inform the member/customer that the Tire Pressure Monitoring System (TPMS) warning light may flash or illuminate continuously until flat tire is repaired or replaced and the system is reset. Other TPMS warning messages may be displayed in the instrument cluster as well.

FUEL SERVICE:

Caution: This vehicle may be equipped with a gasoline or diesel engine. Make certain to add the correct fuel during fuel service. Adding the incorrect fuel may cause serious damage to the engine and fuel system.

Use caution not to spill fuel on the painted surfaces of the vehicle during refueling. Use a proper funnel that is free from dirt and debris.

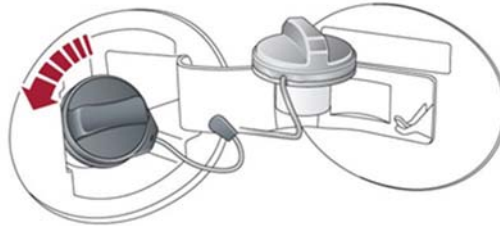

The fuel filler door can be opened when the vehicle is unlocked by pushing it in slightly. There is no emergency release for the filler door.

Gasoline Engine Fuel Octane Rating:

Premium unleaded gasoline with an Anti-Knock Index (AKI) octane rating of 91 or higher should be used.

Diesel Engine Refueling:

A minimum of 1.1 US gallons (4 L) of diesel fuel is required to restart the vehicle.

After Refueling:

- Depress and hold the brake pedal.
- Press and hold the Start/Stop switch and crank the engine for 5 seconds.
- Release the Start/Stop switch.
- With the brake pedal still depressed, press and release the Start/Stop switch to crank the engine. The engine should start within approximately 5 seconds.

Note: Diesel engine vehicles have a miss-fueling flap in the fuel filler neck that requires the use of a special fueling adaptor when adding fuel from a diesel fuel can. It is located in the cargo area with the vehicle's tool kit. An ordinary fueling funnel cannot be substituted.

Caution: Failure to use the diesel fueling adaptor when adding fuel from a diesel fuel can will cause damage to the fuel filler neck.



Diesel Fueling Adaptor

JUMP-START PROCEDURE:

Note:

- Follow all normal jump-starting precautions as outlined in other AAA/CAA publications and those provided by the manufacturer.
- Prior to connecting the boost source, ensure that all electrical accessories and the ignition are turned Off, the transmission is in **P**ark and the electronic key is removed from the disabled vehicle.
- Before attempting to start the vehicle, make sure the vehicle is in **P**ark and that the parking brake is applied and/or wheels chocked.

WARNING: The battery is located in the rear cargo area in the spare tire well. Do not jump-start the vehicle at the battery or the electrical system may be damaged. Use the jump-start pins on the passenger's side of the engine compartment.

Caution: Use a fender cover to prevent scratches or other damage to the vehicle when jump-starting.

Jump-Starting:

- Open the protective red cover for the positive terminal jump pin located on the passenger's side of the engine compartment.
- Connect the positive (Red) cable to the positive terminal jump pin.
- Connect the negative (Black) cable to the negative terminal jump pin.
- Depress the brake pedal and start the engine.
- Disconnect in reverse order.
- Close the red cover on the fuse box.

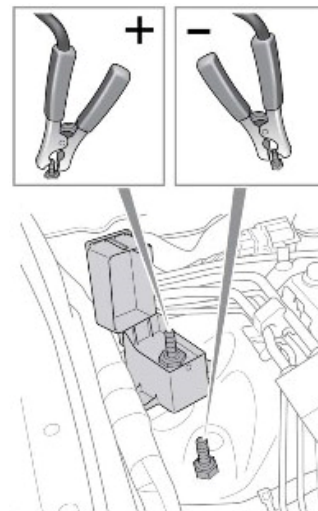

Secondary point to add power to the vehicle:

If power cannot be restored through the under hood jump pins, the following procedure can be performed directly at the battery:

- Follow all the previously listed Cautions and Warnings.
- Connect the positive (Red) cable to the positive terminal of the battery.
- Connect the negative (Black) cable to the battery hold down bolt.

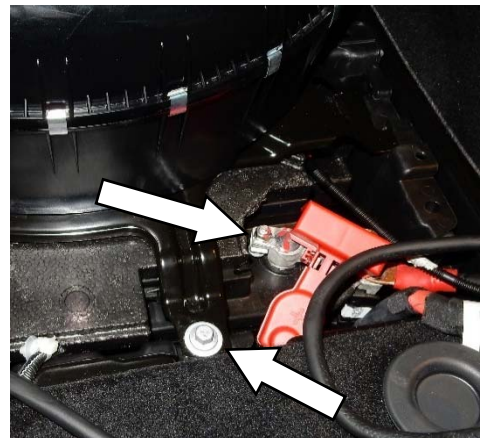

ELECTRONIC KEY:

The electronic key must be inside the vehicle and detected to activate the push-button, Start/Stop system.

Removable Key Blade:

The electronic key also contains a removable mechanical key blade to mechanically lock or unlock the driver's door.

- To access the key blade, slide the cover on the side of the key toward the top. The key blade can then be removed and unfolded.

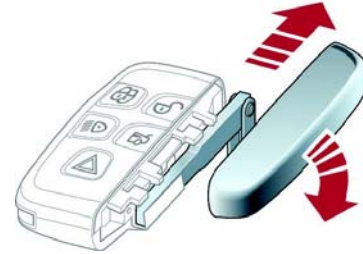

Unlocking the Driver's Door using the Key Blade:

- The driver's door lock cover has a key symbol embossed on it and a slot for the key blade at the bottom. Use the key blade to gently pry off the driver's door lock cover. There is a mechanical key cylinder under the lock cover, which can be unlocked with the key blade. Use caution not to damage the paint or lock cover during removal.
- To reinstall the door lock cover, locate the top retaining lugs first. Press down and latch inward to the single bottom lug. The lug clicks into the locked position. Check the security of the cover to make sure it is properly attached and does not fall off after the vehicle is moving.

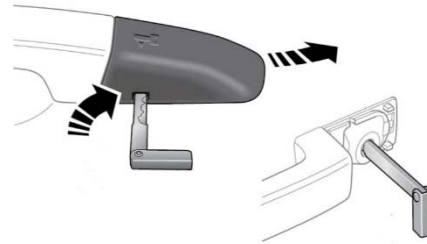

If the Electronic Key is not Detected, try the Following:

Vehicles with Electrically Adjusted Steering Columns:

- Hold the electronic key against the left side of the steering column with the buttons facing out. Depress the brake pedal and start the engine using the start/stop switch.



Vehicles with Manually Adjusted Steering Columns:

- Hold the electronic flat against the underside of the steering column with the buttons facing out. Depress the brake pedal and start the engine using the start/stop switch.

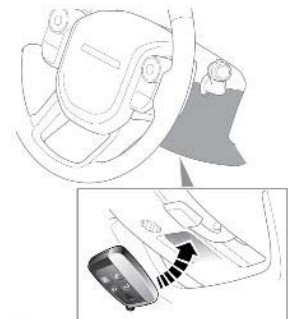

LOCKOUT PROCEDURE:

WARNING! Door placement on these vehicles is quite tight. Use caution when wedging to ensure damage is not done to either the painted surfaces or the weatherstrip. The use of an airbag-style wedge can be beneficial.

OPENING INSTRUCTIONS:

1. Using one or two wedges, carefully open a small gap at the upper rear corner of the right front door. Use a plastic strip or sheet to protect surfaces from scratching.
2. Use a long reaching tool with an "L" tip on the end. Apply tape to the tool tip to help improve its ability to grip and protect interior trim from scratching.
3. Insert the tool through the gap created by wedging and maneuver the tip to contact the interior door release handle.
4. Catch the handle from above and pull to unlock the door. A double pull on the door handle may be needed to unlock the vehicle.
5. Remove the wedges before attempting to open the door.

ALTERNATE METHOD: Use the method listed above, but depress the electric unlock switch instead of pulling on the inside door release handle.



Clean the glass and all surfaces in the entry area before leaving the vehicle.

CAUTION: Do not use excessive force. Wedge only as much opening as needed to enter tool to avoid putting stress on the door glass.